

Turmdrehkran 40 LC

Tower Crane / Grue à tour / Gru a torre
Grúa torre / Guindaste de torre

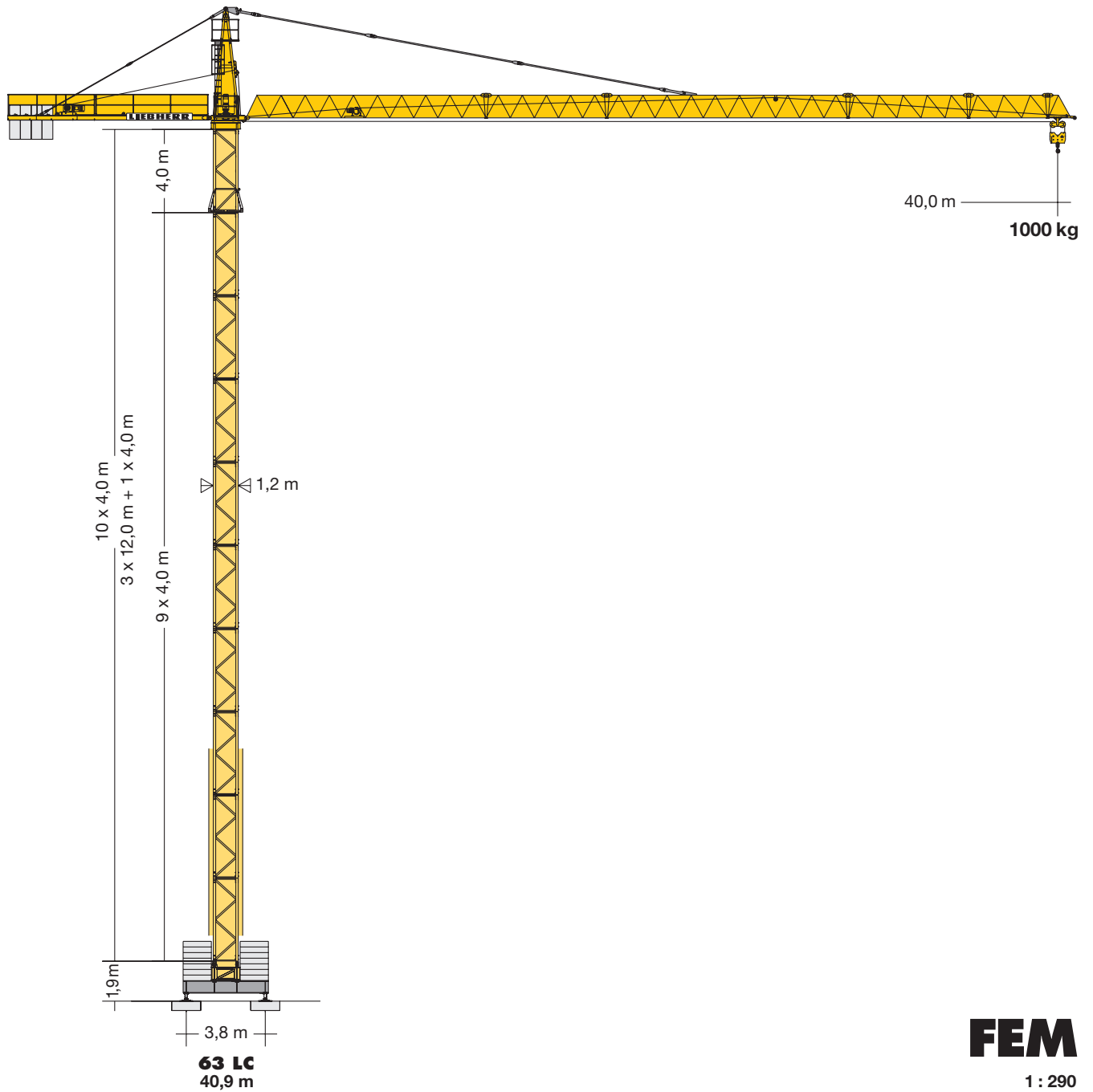

FEM

1 : 290

LIEBHERR

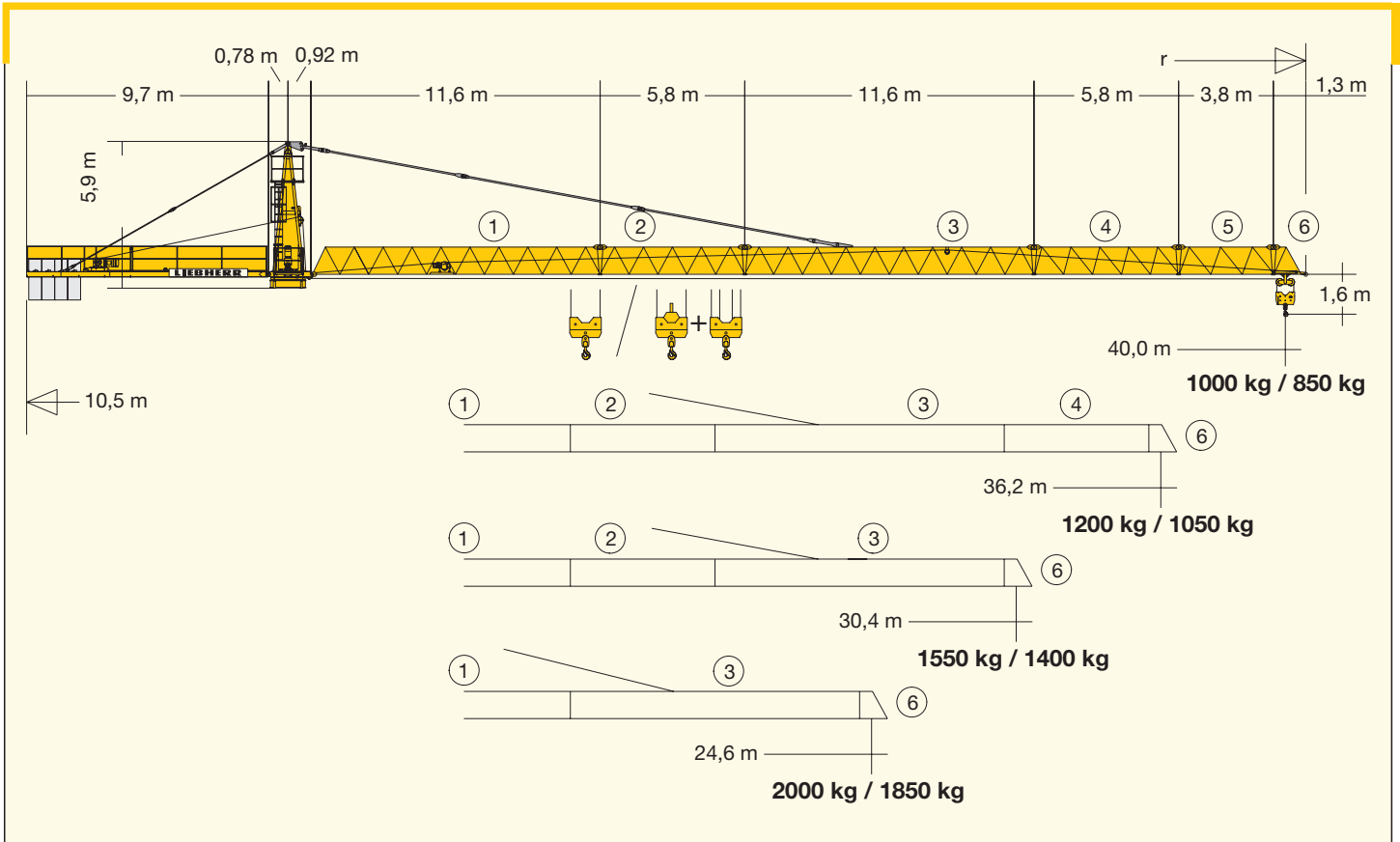

Gewicht Weight / Poids / Peso / Peso / Pesos

Zentralballast / Central ballast Lest de base / Zavorra centrale Lastro central / Lastre central	50000 kg		(Ausl. 40 m)	6600 kg		19100 kg
---	----------	--	--------------	---------	--	----------

Hubhöhe Hoisting height / Hauteur sous crochet / Altezza di sollevamento / Altura bajo gancho / Altura de montagem

		63 LC				
4 m	12 m					
10		–	40,9*	40,5*	39,3*	–
9	3	37,0*	36,9*	36,5*	35,3*	47,1*
8		33,0	32,9	32,5	31,3	43,1*
7		29,0	28,9	28,5	27,3	39,1
6	2	25,0	24,9	24,5	23,3	35,1
5		21,0	20,9	20,5	19,3	31,1
4		17,0	16,9	16,5	15,3	27,1
3	1	13,0	12,9	12,5	11,3	23,1
2		9,0	8,9	8,5	7,3	19,1
1		5,0	4,9	4,5	3,3	15,1
0						11,1
		m	m	m	m	m

* **Weitere Hubhöhen auf Anfrage.** / Further hoist heights on request. / Hauteurs sous crochet sur demande. / Altre altezze di sollevamento: su richiesta. / Outras alturas de elevação: conforme ao pedido. / Para alturas bajo gancho superiores, consultar.
 ** **nicht kletterbar** / not for climbing / non télescopable / non telescopabile / no trepable / no telescopabel

Ausladung und Tragfähigkeit

Radius and capacity / Portée et charge / Sbraccio e portata / Alcances y cargas / Alcance e capacidade de carga

m	r	m/kg	m/kg											
			10,0	12,0	14,0	16,0	18,0	20,0	24,6	27,0	30,4	33,0	36,2	40,0
40,0	(r = 40,9)	2,1-18,7 2500					2500	2310	1810	1620	1400	1270	1130	1000
36,2	(r = 37,1)	2,1-19,5 2500					2500	2430	1900	1710	1480	1340	1200	
30,4	(r = 31,3)	2,1-20,2 2500					2500	2500	1990	1780	1550			
24,6	(r = 25,5)	2,1-20,3 2500					2500	2500	2000					

m	r	m/kg	m/kg		m/kg										
			10,0	12,0	14,0	16,0	18,0	20,0	24,6	27,0	30,4	33,0	36,2	40,0	
40,0	(r = 40,9)	2,1-17,7 2500	2,1-11,9 4000	4000	3980	3310	2820	2440	2150	1660	1470	1250	1120	980	850
36,2	(r = 37,1)	2,1-18,5 2500	2,1-12,4 4000	4000	4000	3490	2970	2580	2270	1750	1560	1330	1190	1050	
30,4	(r = 31,3)	2,1-19,2 2500	2,1-12,7 4000	4000	4000	3630	3100	2690	2370	1850	1630	1400			
24,6	(r = 25,5)	2,1-19,3 2500	2,1-12,7 4000	4000	4000	3630	3100	2690	2370	1850					











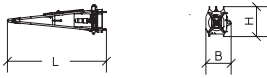
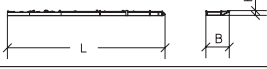

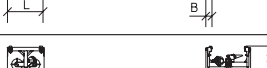

Antriebe

Driving units / Mécanismes d'entraînement / Azionamenti / Mecanismos / Mecanismos

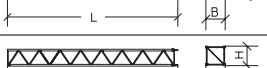
	U/min 0 - 0,8 sl./min tr./min	5,0 kW EDC
	19,0 / 38,0 m/min 21,0 / 42,0 m/min	1,0 / 1,8 kW 1,5 / 3,0 kW
	20,0 m/min	2 x 2,2 kW
	kVA	14,0 kW 14,0 kW FU 22,0 kW 26,0 26,0 35,0

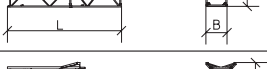
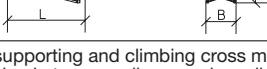
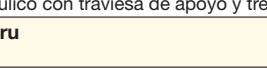
		Stufe / Step Cran / Marcia Marcha / Marcha		kg	m/min
	3,2 / 14,0 / 14,0 kW 57,0 m LS-Trommel	4 Lagen Layers Couches Strati Camadas Capas	1	2500	2500 6,2
			2	2500	2500 27,0
			3	1300	1200 54,0
	90,0 m LS-Trommel	6 Lagen Layers Couches Strati Camadas Capas	1	2400	2300 6,5
			2	2400	2300 28,5
			3	1200	1100 57,0
	149,0 m LS-Trommel	5 Lagen Layers Couches Strati Camadas Capas	1	2500	2500 6,2
			2	2500	2500 28,0
			3	1700	1600 58,0
	57,0 m LS-Trommel	4 Lagen Layers Couches Strati Camadas Capas	1	2500	2500 5,0
			2	2500	2500 25,0
			3	1900	1800 36,0
	90,0 m LS-Trommel	6 Lagen Layers Couches Strati Camadas Capas	4	1300	1200 52,0
			1		4000 2,5
			2		4000 12,5
			3		3800 18,0
			4		2600 26,0
			1	2500	2500 5,2
			2	2500	2500 26,0
			3	1750	1650 37,0
			4	1200	1100 54,0
			1		4000 2,6
			2		4000 13,0
			3		3500 18,5
			4		2350 27,0

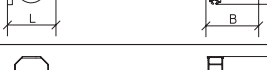
Montagegewichte: siehe Betriebsanleitung. / Erection weights: see instruction manual. / Poids de montage: voir manuel de service.
Pesi di montaggio: vedasi le istruzioni sull'uso. / Pesos de montagem: vejã-se as instruções p. uso. / Peso para el montaje: según manual.

Kranoberteil		Upper part of crane / Partie supérieure de grue / Parte superiore della gru Parte superior grúa / Parte superior do guindaste		L (m)	B (m)	H (m)	kg*	
Pos. Item Rep. Voce Pos. Ref.	Anz. Qty. Qta. Cant.	Turm Spitze mit Kud-Auflage Tower head section with slewing ring support Porte-flèche avec pivot / Testa porta-braccio con supporto ralla Cabeça de apoia de lança / Cabeza de torre con asiento de pista		5,57	1,86	1,73	2530	
1	1							
2	1	Gegenausleger / Counter-jib Contre-flèche / Contrabaccio Contra-lança / Contrapluma		9,79	1,46	0,36	960	
3	1	Ausleger-Anlenkstück / Jib heel section Pied de flèche / Settore articolato di braccio Base articulada de lança / Pluma tramo primero		11,85	1,04	1,30	① 950	
4	1	Ausleger-Zwischenstück / Intermediate jib section Elément intermédiaire de flèche / Spezzone di braccio Peça suplementar da lança / Tramo intermedio pluma		5,94 11,80 5,94 3,94	0,95 0,95 0,95 0,95	1,22 1,32 1,22 1,22	② 336 ③ 618 ④ 210 ⑤ 147	
5	1	Ausleger-Kopfstück / Jib head Pointe de flèche / Punta freccia Cabeça de lança / Tramo punta de pluma		1,45	1,04	1,37	⑥ 80	
6	1	Podeste / Platforms Plates-formes / Plattaforma Plataforma / Plataforma		1,21	0,33	0,77	66	
7	1	Laufkatze / Trolley Chariot / Carrello Carrinho / Carrito		0,95	1,13	0,62	151	
8	1	Unterflasche / Bottom Moufle / Bozzello Gancha / Potipasto		0,75	0,24	0,98	104	
9	1	Hubwerk 11 kW / Winch Treuil / Argano / Mecanismo elevatoria Mecanismo elevación carga		1,25	1,23	0,55	440	
Turm		Tower / Mât / Torre Torre / Torre						
10	1	Turmstück / Tower section Elément de mât / Elemento di torre Torre / Torre		12,0 m 4,0 m	12,27 4,27	1,20 1,20	1,20 1,30	2435 958
11	1	Grundturmstück / Base tower section Mât de base / Elemento di torre base Tramo torre base / Peça de base de torre		12,00	1,42	1,42	3343	
Klettereinrichtung		Climbing equipment / Equipement de télescopage / Attrezzatura per allungamento della gru Equipo de trepado / Acesórios p. subida no edifício						
12	1	Führungsstück kpl. / Guide section cpl. Cage télescopique cpl. / Gabbia de sopraelevazione compl. Peça de guia compl. / Torre de montaje completa		8,92	1,65	1,75	1890	
13	1	KUD-Auflagenverlängerung / Slewing ring support extension Rehausse de pivot d'orientation / Prolunga supporto ralla Peça de guia / Prolongación asiento de pista		4,27	1,66	1,66	1120	
14	1	Hydraulikanlage, Stütz- und Klettertraverse / Hydraulic unit, supporting and climbing cross members Système hydraul. avec traverses d'appui el de télescop. / Sist. idraul., traversa di appoggio e allugam. gru Instalação hidráulica, travessa de apoio e subida / Sistema hidráulico com travessa de apoio y trepade		4,86	0,95	0,70	580	
Unterwagen		Undercarriage / Châssis / Carro della gru Carro con mástil / Carro de guindaste						
15	1	Unterwagen-Rahmen / Undercarriage frame Cadre de châssis / Intelaiatura carro Estrotura do carrinho / Bastidor carretón		4,12	0,94	1,39	2575	
16	2	Tragholm / Arm Longeron / Longherone Travessa / Brazo		4,10	0,30	0,60	935	
17	2	Fahrschemel mit Antrieb / Rail bogie with drive Bogie moteur / Telajo con gruppa propulsore Quadra sem grupa de propulsão / Caja rodillo motriz		0,78	0,84	0,53	297	
18	2	Fahrschemel ohne Antrieb / Rail bogie without drive Bogie fou / Telajo senza gruppa propulsore Quadra com grupa de propulsão / Caja rodillo conducido		0,66	0,30	0,51	204	
19	-	Seile und Kleinteile / Small parts and ropes Accessoire et câbles / Accessori cavi Acessorios e cabos / Accesorios y cables		-	-	-	870	

* Einzelgewichte. / Single weights. / Poids individuels. / Pesi di componenti. / Pesos de peças componentes. / Pesos unitarios.

Konstruktionsänderungen vorbehalten!

Subject to alterations! / Sous réserves de modifications!
Si fa riserva di modifiche! / Salvo modificação da construoão!
¡Sujeto a modificaciones!

Sämtliche Angaben erfolgen ohne Gewähr. / This information is supplied without liability.

Ces renseignements sont sans garantie. / Le indicazioni contenute si intendono salvo errori ed omissioni.
Declinamos toda responsabilidad derivada de la información proporcionada. / Declinamos qualquer
responsabilidade quanto à informação fornecida.